

HEURISTIC POWER FLOW ALGORITHM FOR APPLICATION IN ACTIVE DISTRIBUTION GRIDS

N. Nikmehr¹ S. Najafi Ravadanegh²

1. Department of Engineering, College of Electrical, Science and Research Branch, Islamic Azad University, Ahar, Iran
nima.alamdari@yahoo.com

2. Smart Distribution Grid Research Lab, Electrical Engineering Department, Shahid Madani University, Tabriz, Iran
s.najafi@azaruniv.edu

Abstract- Power Flow (PF) analysis is a basic and major task in operation, expansion and planning of power systems. By appearance of renewable energy resources as major components of active distribution grids, the problem of power flow may be encounter with some new challenges. Most of the power flow solutions especially in distribution networks are based on mathematical formulation, which is solved using iterative techniques. In this paper to overcome the deficiency of conventional power flow solvers at smart distribution grids a method based on application of heuristic optimization is proposed. The presented method can overcome some unexpected condition in future distribution grids power flow problem such as weakly mesh topology of future distribution networks, high ratio of R/X , integration of distributed generation into conventional distribution networks, as well as ill condition of load flow Jacobian matrix in heavy loads. The presented algorithm is tested using two heuristic algorithm namely, Imperialist Competitive Algorithm (ICA) and Particle Swarm Optimization (PSO). The obtained results is compared by Backward-Forward (BF) method on 33-bus test system with 24 hours load profile. The results confirm the capability, efficiency and flexibility of the presented algorithm.

Keywords: Power Flow, Active Distribution Grids, Distributed Generation, Heuristic Algorithm, ICA, PSO.

I. INTRODUCTION

The flow of active and reactive power from generation to the load through network buses and branches is called load flow or power flow (PF). Load flow studies using mathematical methods determine various bus voltage magnitudes and angles, and consequently the active and reactive power of each branch is calculated in steady state conditions. PF analysis has been used in operating and planning of power systems. The advantages of the PF studies are minimization of transmission losses, planning of new networks, determining the best location and optimal capacity of substation and new lines and etc.

Common method for solving load flow problem in transmission systems are Newton-Raphson and

Gauss-Seidel methods that these are iterative techniques. Load flow problem is solved using by Newton's technique [1] and fast decoupled method [2] in the transmission networks.

The above techniques are not an efficient method in distribution systems. There is some particular features in distribution networks such as radial operation, weakly meshed structure by integrating DGs and high R/X ratio, which caused ill conditioned for Newton-Raphson and fast-decoupled methods. In [3] power flow problem is solved with considering ill-conditioned constraints [3]. Proposed method in [4] is suited for solving load flow problem in radial and weakly meshed systems.

In [5] the "branch to branch computation method" is introduced that is relevant for solving load flow problem in radial distribution system. Reference [6] uses simple algebraic recursive expression of voltage magnitude to solve power flow problem with considering unbalanced three-phase in radial networks. Authors of [7] solve power flow problem by using Newton-Raphson by considering unbalanced and multiphase distribution systems.

Most of developed techniques for distribution systems are based on backward-forward sweep method. Paper [8] utilized backward-forward sweep technique based on impressive branch and nodal numbering scheme. The proposed technique in [9] is based on forward sweep method and evaluates node parameters based on KVL and KCL laws. In [10] charging capacitance of the branches is regarded in model of forward sweep technique and then voltage drop and node voltage are calculated.

In [11] power flow solution in distribution system at presence of wind generators with varying wind speeds is considered. Presented method in [12] is based on primitive impedance of the lines and used unbalanced distribution systems. The backward sweep techniques, changes in values of the active and reactive power are regarded in [13]. In recent years, the PF has been solved by using heuristic methods with some researchers. Author in [14] first formulated power flow solution as conic optimization problem, and then used interior-point method to solve the problem.

Paper [15] uses two matrices that including structural features of distribution system for solving PF problem. In [16], load flow problem is solved by using interval arithmetic distribution system by considering stochastic load parameters. In [17], authors offer a technique for solving load flow in distribution system that known node depth encoding method. PF problem in [18] is solved with fuzzy logic laws in distribution networks.

Paper [19] defines a new dynamic data structure to solve load flow problem in radial system with harmonic components. The power flow solution for composite known load modeling in radial distribution systems is presented in [20]. The presented method in [21] solves load flow problem in large distribution system in a remotely distributed environment and considers distributed system.

This paper presented a new method based on evolutionary algorithms for solving PF problem in future distribution grids including DGs and weakly meshed networks. Imperialist Competitive Algorithm (ICA) and Particle Swarm Optimization (PSO) techniques have been used to optimize and compare the obtained results of the load flow solution. This method can be implemented for each structure of distribution system such as radial and weakly meshed distribution systems with and without DGs. The load profile of distribution network assumed to be varied in 24 hours of day. Therefore, the proposed method has been examined for different load profile in 24 hours of a day. The results show the capability, efficiency and flexibility of the proposed method.

II. POWER FLOW PROBLEM

PF is one of the most essential tasks in the power system operation and planning. Following handling the PF, the voltage magnitude and angle in PQ buses, and the reactive power generation and voltage angle in PV buses are available. The PF problem is formulated in several technical references [22-25]. Substantially, PF basic equations are expressed as follows:

$$P_i^{sch} = \sum_{g=1}^{G_i} P_i^g - \sum_{d=1}^{D_i} P_i^d \quad (1)$$

$$Q_i^{sch} = \sum_{g=1}^{G_i} Q_i^g - \sum_{d=1}^{D_i} Q_i^d \quad (2)$$

$$P_i^{calc} = \sum_{j=1}^{n-1} (|V_i||V_j||Y_{ij}| \cos(\theta_{ij} - \delta_i + \delta_j)) \quad (3)$$

$$Q_i^{calc} = -\sum_{j=1}^{n-1} (|V_i||V_j||Y_{ij}| \sin(\theta_{ij} - \delta_i + \delta_j)) \quad (4)$$

where, P_i^g and Q_i^g are generated real and reactive powers at bus i , respectively. P_i^d and Q_i^d are consumption real and reactive powers at bus i .

The inequality constraints, which cooperated with PF problem, include the allowable limits for voltage magnitude of all nodes except slack and PV buses and voltage phase angle of all nodes except slack bus.

$$|V_{i,\min}| < |V_i| < |V_{i,\max}| \quad (5)$$

$$|\delta_{i,\min}| < |\delta_i| < |\delta_{i,\max}| \quad (6)$$

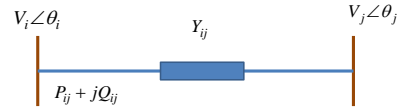

Figure 1. Distribution line model

III. EVOLUTIONARY ALGORITHMS

A. Review of Imperialist Competitive Algorithm (ICA)

Imperialist competition algorithm is a new evolutionary optimization method that is inspired by imperialist competition [26]. Like other evolutionary algorithms, ICA starts with an initial population, which is called country. Countries in ICA divided into two types called colonies and imperialists that together form empires. They are similar to chromosome in genetic algorithm and PSO.

Every country defined as a vector with socio-political characteristics such as culture, language, and religion. ICA is implemented in sequential Stages as follows, generating initial empires, assimilation, revolution, exchange between the best colony and imperialist, Imperialistic competition, elimination of powerless empire.

B. Generating Initial Empires

At the beginning of the algorithm, an initial population called countries should be created. In an N dimensional optimization problem, a country is a $1 \times N$ array as follows:

$$country = [x_1, x_2, \dots, x_i] \quad (7)$$

where, x_i is the variable that to be optimized and similar to gen in genetic algorithm. The cost function of each country is calculated by using variables (x_1, x_2, \dots, x_i) as follows:

$$cost_i = f(country_i) = f(x_1, x_2, x_3, \dots, x_{N_{var}}) \quad (8)$$

Firstly, initial countries $N_{country}$ are created, and then N_{imp} number of created countries considered as imperialist countries and remained 17 countries considered as colonies of imperialist countries. Dividing colonies between imperialists has been performed based on ratio of the power. For this purpose, with cost function of imperialists, the normalized value of costs calculated as follows:

$$C_n = \max_i \{c_i\} - c_n \quad (9)$$

where, $\max_i \{c_i\}$ is maximum value of cost between imperialists cost.

The imperial with maximum cost is the weakest imperial and the normalized cost of weakest imperial has less than other. The colonies divide between imperialists based-on normalized cost with following equation.

$$x_n = \left| \frac{C_n}{\sum_{i=1}^{N_{imp}} C_i} \right| \quad (10)$$

The initial number of colonies of an imperialist is calculated as follow:

$$NC_n = \text{round}\{x_n (N_{col})\} \quad (11)$$

Figure 2 portrays dividing colonies between imperialists. As shown in Figure 2 empires with the higher power have a large number of colonies.

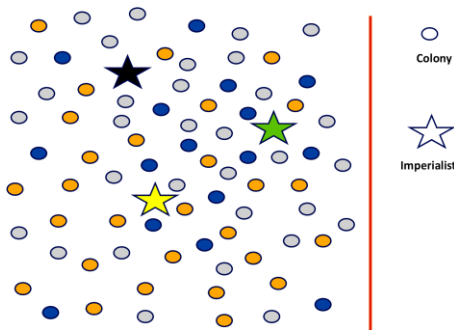

Figure 2. Generating of initial empires

C. Assimilation

The original version of ICA operates in continues procedure. All the imperialist countries compete for taking possession of colonies of each other. In addition, assimilation is modeled by moving the colonies toward the imperialists based on culture, social structure, language and etc. This movement has been illustrated in Figure 3. In Figure 3 a colony moves toward the imperialist by a random value that is uniformly distributed between 0 and $\beta \times a$ as follows:

$$\{position\}_{new} = \{position\}_{old} + U(0, \beta \times d) \times \{V_1\} \quad (12)$$

where, $\{V_1\}$ is a movement direction vector with unit length, which its directions from previous location of the colony toward the imperialist locations.

To increase the search ability among the imperialists, a random deviation is added to the direction of movement. The new direction will change the size of θ , and θ is a random number with uniform distribution as:

$$\theta = U(-\gamma, +\gamma) \quad (13)$$

D. Updating Positions of the Imperialists

During the previous stage, cost of a colony may reach to a lower position than imperialist. In this case, the positions of the imperialist and that colony should be exchanged, and rest of the colonies of this empire move toward the new position of the imperialist.

E. Calculating Total Power of an Empire

Total power of an empire is power this imperialist and its colonies. Power of an imperialist is more effective than the power of its colonies. The total power of an empire is defined as:

$$T.C_n = Cost(imperialist_n) + \xi \text{mean}\{Cost(colonies\ of\ empire_n)\} \quad (14)$$

where, ξ is a positive number considered to be less than 1. The ξ describes the role of the colonies in total power of an empire.

F. Imperialistic Competition

In this stage, all of the empires try to take possession of the colonies of other empires. In imperialistic competition, weakest colony of weakest empire is moved toward to other empires based on total power of empires. Therefore, the more powerful empires have greater chance to possess the mentioned colony. The normalized total power of each empire is calculated as follows:

$$NTC_n = \max_i \{TC_i\} - TC_n \quad (15)$$

The possession probability of each empire is calculated as below:

$$x_{x_n} = \left| \frac{NTC_n}{\sum_{i=1}^{N_{imp}} NTC_i} \right| \quad (16)$$

We use Roulette wheel method for assigning the mentioned colony to the empires. Imperialistic competition has been shown in Figure 4.

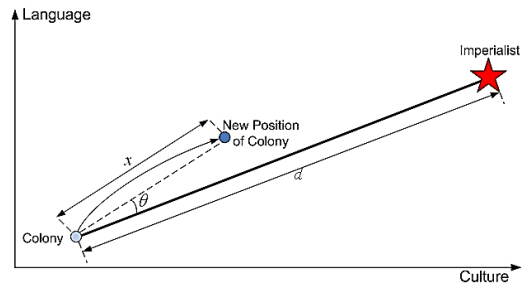

Figure 3. Moving colonies direction [26]

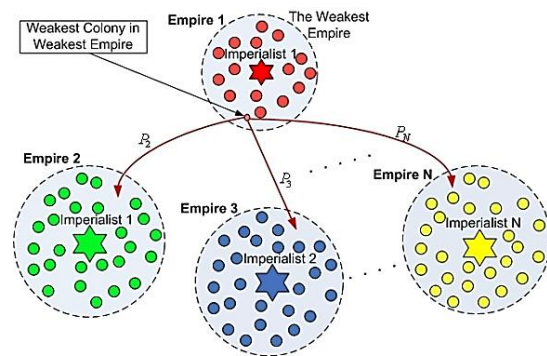

Figure 4. Imperialist competition [26]

G. Eliminating the Powerless Empires

When all of the colonies of one empire assigned to other empires, this imperialist has been collapsed and this country considered as a colony and should be assigned to other empires.

H. Convergence

After enough imperialistic competitions, the most powerful imperialist exist, other empires collapsed, and all of the countries became colonies of powerful empire. All the colonies have the same positions and the same costs, and there is no difference between the colonies and their imperialist. This is optimal solution of the problem.

I. Review of PSO Algorithm

The main idea of the PSO algorithm is inspired first by Kennedy and Eberhart [27] in 1995. The idea is suggested from offensive particles movement such as birds or fish. When the birds want to move, they use present position and neighbor bird's position in order to reach bird with the best position. In PSO algorithm instead of birds or fish, particles do this work. Any of particles are described with two vectors V_i and S_i .

In every movement steps of particles population, every particle is updated by two values. First value is the best previous position of particle i that called p -best and evaluated by using fitness function. Second value is the best particle among all p -bests that called g -best. By finding these values, any of particles update their new velocity and position by following relations:

$$V_i^{k+1} = WV_i^k + C_1 \text{rand}_1 \times (p_best_i - S_i) + C_2 \text{rand}_2 \times (g_best - S_i) \quad (17)$$

$$S_i^{k+1} = S_i^k + V_i^{k+1} \quad (18)$$

$$W = W_{\max} - \frac{(W_{\min} - W_{\max})}{iter_{\max}} \times iter \quad (19)$$

where, C_1 and C_2 are acceleration constant in range [0, 2]. rand_1 and rand_2 are uniform random value in range [0, 1].

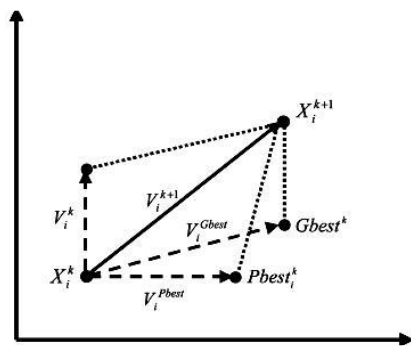

Figure 5. The path of the particles movement [27]

PSO algorithm can be described as follows steps:

Step 1- The velocity and position vectors are initialized randomly.

Step 2- The velocity vector of the all particles is updated by using Equation (17).

Step 3- The position vector of the all particles is updated by using Equation (18).

Step 4- Memory update. P -best $_i$ and g -best are updated as follows:

$$\text{if } F(p_i) < F(p_best_i) \Rightarrow p_i \rightarrow p_best_i \quad (20)$$

$$\text{if } F(p_i) < F(g_best) \Rightarrow p_i \rightarrow g_best \quad (21)$$

IV. IMPLEMENTATION OF THE EVOLUTIONARY ALGORITHMS ON PF PROBLEM

As mentioned earlier, several classic methods for PF study have been developed. Power flow problem is a non-linear programming. Therefore solving the problem by classic methods has convergence problem and used on certain networks structure. A solution for solving this problem in PF problem is using evolutionary algorithms. In addition, the obtained results of PF solution are optimized. Evolutionary algorithms can be easily used to all distribution grids with considering each structure in the grid such as weakly meshed and DG included networks.

So, a new algorithm has been introduced here for solving PF problem by using EA. In order to implement the EA on the load flow problem, the magnitude and phase

angle of the voltages of PQ buses and voltage phase angle of PV buses are selected as decision variables. In ICA algorithm, the initial population is established randomly. Several set of initial estimations (i.e. countries) are created for PQ and PV bus voltages.

Voltage magnitude and phase angle in PQ bus and phase angle in PV bus play the role of the socio-political features such as culture and language in ICA. Then, the cost function presented in Equation (3) is calculated by using Equation (10). It is assumed that distribution network has n bus, which one bus is slack and others are PQ , and PV buses. The number of decision variables of this network and variable load in 24 hours of day is $2(n-1) \times 24$. Objective function of proposed evolutionary PF defined as follows:

$$\min \{ Z = \text{sum} (F) \} \quad (22)$$

$$F_i = F_{p_i}^2 + F_{Q_i}^2 \quad (23)$$

$$F_{p_i} = \sum_{i \in PV, PQ \text{ buses}}^n |P_i^{calc} - P_i^{sch}| \quad (24)$$

$$F_{Q_i} = \sum_{i \in PV, PQ \text{ buses}}^n |Q_i^{calc} - Q_i^{sch}| \quad (25)$$

Objective function (Z) minimized by ICA and PSO algorithms in this paper. Figure 6 shows the flowchart of proposed evolutionary PF by using of the ICA.

V. TEST CASES AND RESULTS

At future distribution networks, the penetration of renewable energy sources and other such as PHEVs may change the radial distribution network to a weakly meshed network with high R/X ration. This situation need for method to calculate the power flow as a basic calculation in active distribution networks. The proposed method has been tested on different standard test networks. In order to show the accuracy of the presented method, three standard distribution networks have been studied, 33-bus radial distribution grid, 33-bus weakly meshed distribution grid with regarding two DG units.

Table 1. ICA parameters used for systems

Iteration or Decades Number	100
Initial countries Number	80
Imperialist countries Number	10
Colonies Number	70

The line and bus data of these networks is given in [28-30] respectively. Two heuristic algorithms namely ICA and PSO are used in order to obtain voltages magnitude, & results are compared with Newton-Raphson (NR) method. A 24 hours load profile is assumed in each node of networks. After simulation sample results of proposed method for 1st, 9th, 17th and 24th hours are presented for each case study. Parameters of ICA and PSO algorithms are presented in Tables 1 and 2, respectively.

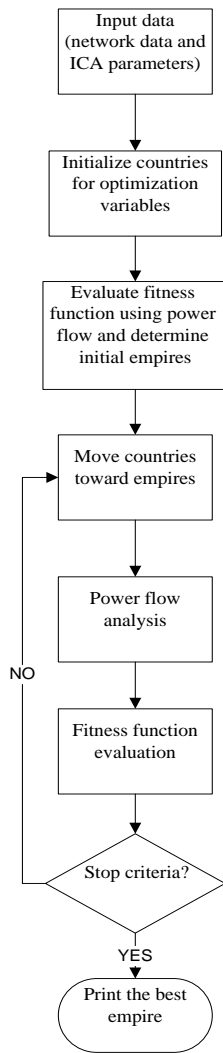

Figure 6. Flowchart of the implementation of ICA on power flow problem

A. 33-Bus Radial Distribution System

In this case, 33-bus standard network has been tested. The single diagram of system is available in Figure 7.

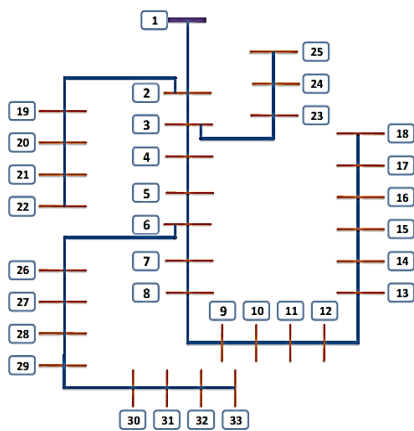
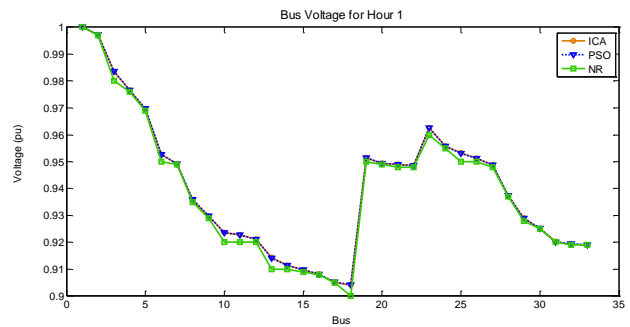

Figure 7. IEEE 33-bus distribution system

Table 3 shows the results of load flow using ICA, PSO and NR methods considering 4-hour timeframe in 33-bus radial distribution system. In Figures 8(a) and 8(b)

comparison of obtained voltage profile by ICA and NR for 2 hours in 33-bus radial system is indicated. Table 3 shows sample results of proposed evolutionary LF at 4 hours by using ICA and PSO, and obtained results are compared with NR method.

This figure shows that achieved results by ICA are better than given results by NR method. Table 4 shows the comparison of the best cost and running time between ICA and PSO algorithm and NR method. Base on this table the value of cost function for ICA and PSO is smaller than NR but the execution time is larger for two heuristic methods.



(a)

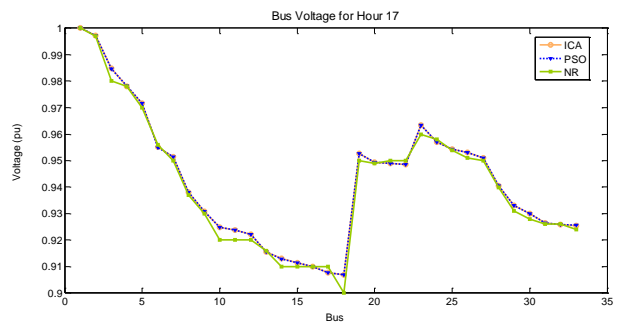

(b)

Figure 8. Compare obtained voltage profile by ICA and NR

Table 2. PSO parameters used for systems

Iteration Number	100
Number of Particles	80

Figure 9 shows the convergence of ICA algorithm. Figure 10 shows the voltage profile in 3-dimensional mode with ICA method, and Figure 11 shows the voltage profile in 3-dimensional mode by using NR for 24 hours of day. To compare the obtained results by ICA and NR Figure 12 describes difference on obtained results from ICA and NR method in 3-dimensional mode.

B. 33-Bus Weakly Meshed Distribution System with 2 DG Units

Because the nature of future distribution network in which the renewable energy resources is added into the network. The radial structure of the network will be changed into a weakly meshed network with voltage control capability at distribution level. The proposed method can use for weakly meshed distribution grids without any difficulties. The single diagram of the network is illustrated in Figure 13.

Table 3. Results of load flow using ICA, PSO and NR methods considering 4-hour timeframe in 33-bus radial distribution system

Bus Number	Hour 1			Hour 9			Hour 17			Hour 24		
	ICA	PSO	NR	ICA	PSO	NR	ICA	PSO	NR	ICA	PSO	NR
1	1.0000	1.0000	1.000	1.0000	1.0000	1.000	1.0000	1.0000	1.000	1.0000	1.0000	1.000
2	0.9972	0.9973	0.997	0.9984	0.9983	0.998	0.9973	0.9973	0.997	0.9966	0.9965	0.996
3	0.9835	0.9836	0.980	0.9901	0.9902	0.990	0.9848	0.9847	0.980	0.9791	0.9792	0.979
4	0.9765	0.9766	0.976	0.9857	0.9856	0.985	0.9781	0.9782	0.978	0.9703	0.9704	0.970
5	0.9696	0.9697	0.969	0.9813	0.9813	0.980	0.9716	0.9717	0.970	0.9618	0.9617	0.960
6	0.9526	0.9526	0.950	0.9701	0.9700	0.970	0.9551	0.9550	0.956	0.9400	0.9400	0.938
7	0.9491	0.9491	0.949	0.9676	0.9676	0.967	0.9515	0.9515	0.950	0.9354	0.9355	0.940
8	0.9358	0.9359	0.935	0.9579	0.9579	0.956	0.9380	0.9380	0.937	0.9203	0.9202	0.920
9	0.9298	0.9298	0.929	0.9535	0.9534	0.950	0.9309	0.9309	0.930	0.9135	0.9136	0.910
10	0.9237	0.9237	0.920	0.9491	0.9491	0.949	0.9248	0.9248	0.920	0.9070	0.9070	0.906
11	0.9228	0.9227	0.920	0.9485	0.9486	0.948	0.9239	0.9239	0.920	0.9061	0.9060	0.906
12	0.9211	0.9212	0.920	0.9474	0.9475	0.947	0.9222	0.9222	0.920	0.9043	0.9044	0.903
13	0.9143	0.9142	0.910	0.9429	0.9430	0.940	0.9155	0.9155	0.916	0.8975	0.8975	0.897
14	0.9114	0.9114	0.910	0.9413	0.9414	0.940	0.9130	0.9129	0.910	0.8947	0.8948	0.890
15	0.9098	0.9097	0.909	0.9403	0.9403	0.940	0.9115	0.9115	0.910	0.8930	0.8931	0.890
16	0.9081	0.9081	0.908	0.9393	0.9393	0.939	0.9100	0.9100	0.910	0.8914	0.8914	0.891
17	0.9051	0.9052	0.905	0.9378	0.9379	0.937	0.9077	0.9077	0.910	0.8885	0.8885	0.886
18	0.9042	0.9043	0.900	0.9374	0.9375	0.940	0.9070	0.9070	0.900	0.8876	0.8876	0.886
19	0.9515	0.9514	0.950	0.9680	0.9681	0.970	0.9527	0.9527	0.950	0.9430	0.9430	0.940
20	0.9494	0.9494	0.949	0.9662	0.9662	0.967	0.9494	0.9494	0.949	0.9399	0.9400	0.940
21	0.9490	0.9490	0.948	0.9657	0.9658	0.966	0.9490	0.9490	0.950	0.9392	0.9392	0.939
22	0.9485	0.9485	0.948	0.9654	0.9654	0.965	0.9485	0.9486	0.950	0.9385	0.9384	0.938
23	0.9625	0.9625	0.960	0.9759	0.9759	0.974	0.9635	0.9635	0.960	0.9540	0.9540	0.950
24	0.9557	0.9557	0.955	0.9723	0.9724	0.970	0.9571	0.9571	0.958	0.9442	0.9442	0.940
25	0.9532	0.9531	0.950	0.9706	0.9705	0.970	0.9544	0.9544	0.954	0.9400	0.9401	0.940
26	0.9513	0.9512	0.950	0.9693	0.9692	0.970	0.9531	0.9531	0.951	0.9377	0.9378	0.938
27	0.9488	0.9488	0.948	0.9679	0.9678	0.967	0.9510	0.9510	0.950	0.9344	0.9345	0.930
28	0.9373	0.9374	0.937	0.9608	0.9608	0.960	0.9406	0.9405	0.940	0.9189	0.9189	0.919
29	0.9289	0.9289	0.928	0.9559	0.9559	0.956	0.9330	0.9330	0.931	0.9075	0.9075	0.906
30	0.9251	0.9252	0.925	0.9538	0.9538	0.950	0.9299	0.9299	0.928	0.9025	0.9025	0.900
31	0.9203	0.9202	0.920	0.9515	0.9515	0.950	0.9264	0.9264	0.926	0.8964	0.8965	0.895
32	0.9193	0.9194	0.919	0.9511	0.9510	0.950	0.9258	0.9259	0.926	0.8952	0.8951	0.895
33	0.9191	0.9191	0.919	0.9508	0.9507	0.950	0.9255	0.9256	0.924	0.8948	0.8947	0.890

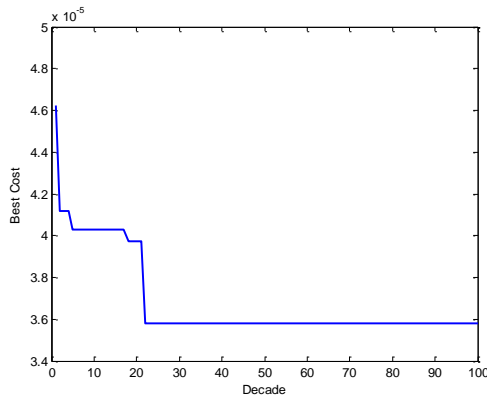

Figure 9. Convergence of ICA algorithm to solve load flow

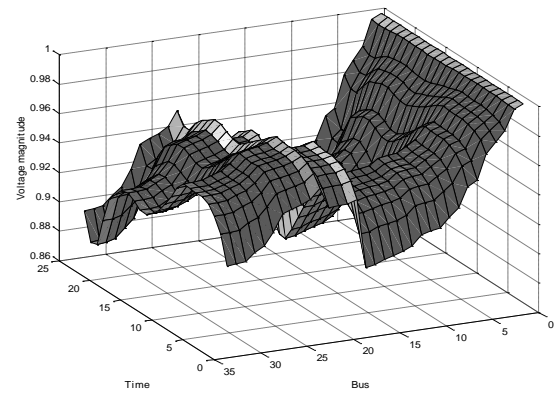

Figure 11. 3-Dimensional voltage for 33-bus radial system using NR

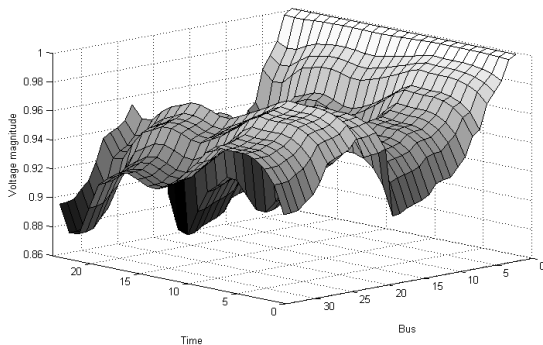

Figure 10. 3-Dimensional voltage for 33-bus radial system using ICA

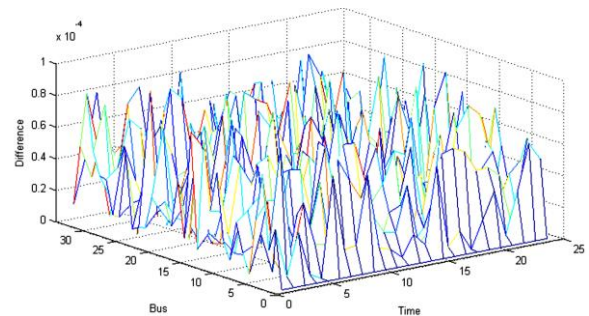

Figure 12. Difference between ICA and NR methods in obtained voltage magnitude for 33-bus radial grid

Table 4. Comparison of best cost and execution time given by ICA, PSO and NR methods in 33-bus radial system

Method	Best Cost	Running Time (s)
ICA	4.134 e -007	6.6082
PSO	4.257 e -007	6.7223
NR	1 e -003	0.1560

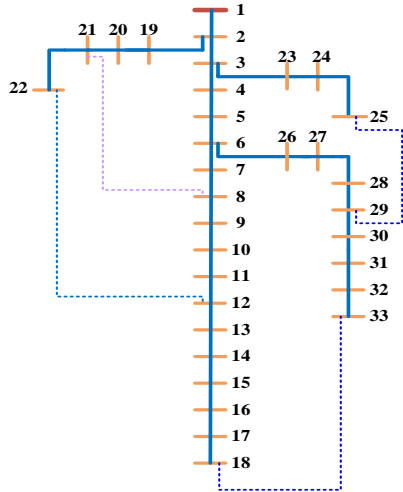
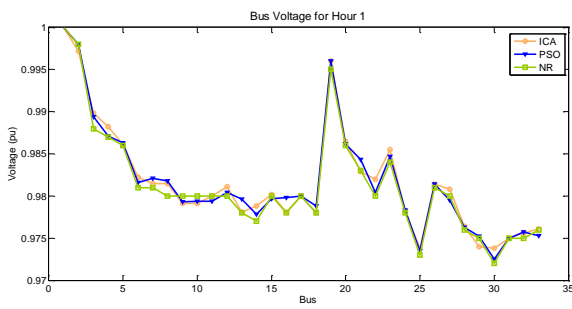

Figure 13. IEEE 33-bus weakly meshed distribution system

Table 5. The data of the wind turbines in 33-bus weakly meshed distribution system

WT place	P (kW)	Voltage magnitude (pu)
17	100	0.98
31	100	0.975

Table 7 Comparison of best cost and execution time given by ICA, PSO and NR methods in 33-bus weakly meshed with 2 DG units.



(a)

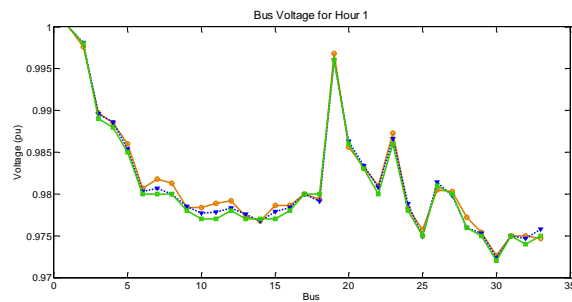

(b)

Figure 14. Compare obtained voltage profile by ICA and NR at 2 hours in 33-bus weakly meshed system

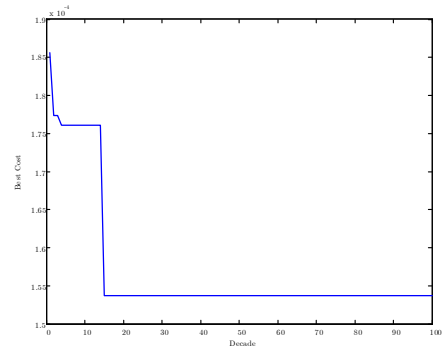

Figure 15. Convergence of ICA in 33-bus weakly meshed grid

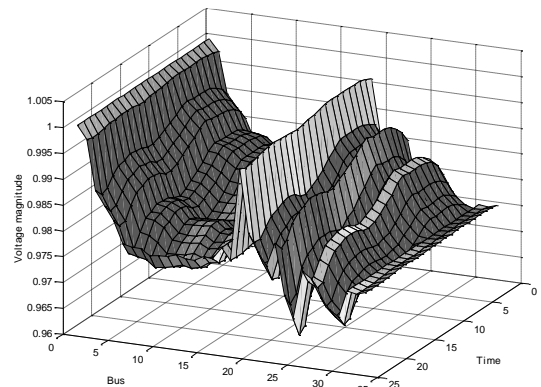

Figure 16. 3-Dimensional voltage for 33-bus weakly meshed system using ICA

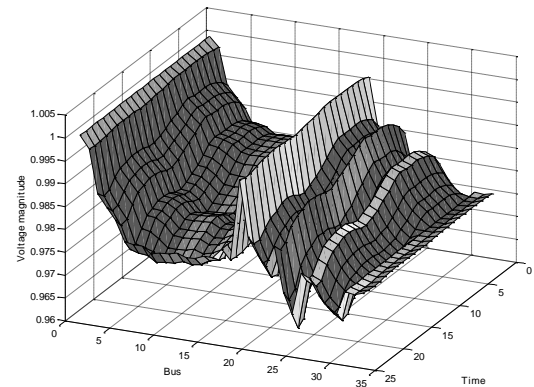

Figure 17. 3-Dimensional voltage for 33-bus weakly meshed system using NR

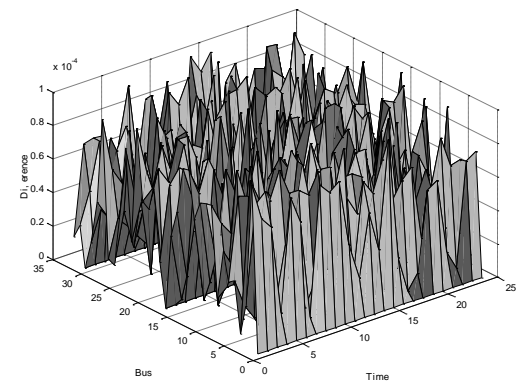

Figure 18. Difference of ICA and NR methods in obtained voltage magnitude for 33-bus weakly meshed with 2 DG units

Nowadays, renewable energies such as wind turbines are considered in distribution networks. Presented method can solve the power flow problem at presence wind turbines (WT) for example. In this case, the 33-bus weakly meshed distribution network with two DG units connected at bus 17 and bus 31 is considered. The active power of each wind turbine is supposed to be 100 kW as Table 5. Table 5 The data of the wind turbines in 33-bus weakly meshed distribution system.

Table 7. Comparison of best cost and execution time given by ICA, PSO and NR methods in 33 bus weakly meshed with 2 DG units

Method	Best Cost	Running Time (s)
ICA	1.402 e -005	6.561
PSO	1.462 e -005	6.810
NR	1 e -003	0.231

Table 6 related to results of three methods in solving of load flow problem with considering variable load consumption. The voltage profile of the grid by solving LF with ICA and NR has been shown in Figure 14(a) and 14(b). Table 6 Results of load flow using ICA, PSO and NR methods considering 4-hour timeframe in 33-bus weakly meshed distribution system with 2 DG units. The convergence of ICA algorithm has shown in Figure 15.

Table 6. Results of load flow using ICA, PSO and NR methods considering 4-hour timeframe in 33-bus weakly meshed system with 2 DG units

Bus Number	Hour 1			Hour 9			Hour 17			Hour 24		
	ICA	PSO	NR	ICA	PSO	NR	ICA	PSO	NR	ICA	PSO	NR
1	1.0000	1.0000	1.000	1.0000	1.0000	1.000	1.0000	1.0000	1.000	1.0000	1.0000	1.000
2	0.9972	0.9980	0.998	0.9983	0.9991	0.999	0.9976	0.9981	0.998	0.9980	0.9976	0.997
3	0.9898	0.9894	0.988	0.9931	0.9938	0.991	0.9897	0.9896	0.989	0.9881	0.9868	0.987
4	0.9882	0.9871	0.987	0.9904	0.9907	0.990	0.9885	0.9886	0.988	0.9859	0.9853	0.985
5	0.9861	0.9863	0.986	0.9889	0.9885	0.988	0.9860	0.9854	0.985	0.9822	0.9823	0.982
6	0.9822	0.9816	0.981	0.9858	0.9854	0.985	0.9807	0.9803	0.980	0.9787	0.9783	0.978
7	0.9815	0.9821	0.981	0.9855	0.9856	0.985	0.9818	0.9807	0.980	0.9770	0.9779	0.977
8	0.9815	0.9818	0.980	0.9839	0.9838	0.982	0.9813	0.9800	0.980	0.9776	0.9784	0.977
9	0.9791	0.9793	0.980	0.9827	0.9815	0.981	0.9784	0.9785	0.978	0.9757	0.9761	0.975
10	0.9791	0.9794	0.980	0.9818	0.9817	0.980	0.9784	0.9777	0.977	0.9761	0.9778	0.977
11	0.9800	0.9794	0.980	0.9820	0.9823	0.981	0.9789	0.9778	0.977	0.9765	0.9769	0.976
12	0.9811	0.9804	0.980	0.9827	0.9819	0.981	0.9792	0.9783	0.978	0.9771	0.9783	0.978
13	0.9781	0.9796	0.978	0.9808	0.9814	0.981	0.9773	0.9776	0.977	0.9762	0.9772	0.976
14	0.9788	0.9778	0.977	0.9811	0.9809	0.980	0.9768	0.9768	0.977	0.9766	0.9764	0.977
15	0.9802	0.9797	0.980	0.9805	0.9800	0.980	0.9786	0.9779	0.977	0.9771	0.9781	0.977
16	0.9781	0.9798	0.978	0.9814	0.9804	0.980	0.9786	0.9784	0.978	0.9780	0.9780	0.975
17	0.9800	0.9800	0.980	0.9800	0.9800	0.980	0.9800	0.9800	0.980	0.9800	0.9800	0.980
18	0.9780	0.9788	0.978	0.9794	0.9781	0.978	0.9794	0.9791	0.980	0.9769	0.9782	0.977
19	0.9960	0.9960	0.995	0.9979	0.9974	0.997	0.9968	0.9960	0.996	0.9962	0.9965	0.996
20	0.9865	0.9862	0.986	0.9900	0.9895	0.989	0.9856	0.9863	0.986	0.9841	0.9832	0.983
21	0.9829	0.9843	0.983	0.9872	0.9877	0.987	0.9832	0.9834	0.983	0.9800	0.9793	0.980
22	0.9820	0.9804	0.980	0.9840	0.9856	0.984	0.9810	0.9808	0.980	0.9795	0.9785	0.978
23	0.9855	0.9847	0.984	0.9906	0.9905	0.990	0.9873	0.9866	0.986	0.9814	0.9821	0.981
24	0.9782	0.9783	0.978	0.9842	0.9859	0.985	0.9783	0.9788	0.978	0.9732	0.9726	0.972
25	0.9738	0.9735	0.973	0.9822	0.9821	0.982	0.9757	0.9749	0.975	0.9684	0.9684	0.968
26	0.9814	0.9814	0.981	0.9841	0.9850	0.984	0.9805	0.9814	0.981	0.9781	0.9777	0.977
27	0.9808	0.9795	0.980	0.9830	0.9847	0.983	0.9803	0.9798	0.980	0.9775	0.9771	0.977
28	0.9764	0.9763	0.976	0.9806	0.9804	0.980	0.9772	0.9760	0.976	0.9741	0.9724	0.972
29	0.9740	0.9752	0.975	0.9781	0.9777	0.977	0.9754	0.9753	0.975	0.9707	0.9714	0.971
30	0.9738	0.9725	0.972	0.9761	0.9760	0.975	0.9726	0.9724	0.972	0.9708	0.9693	0.970
31	0.9750	0.9750	0.975	0.9750	0.9750	0.975	0.9750	0.9750	0.975	0.9750	0.9750	0.975
32	0.9756	0.9757	0.975	0.9742	0.9744	0.974	0.9750	0.9747	0.974	0.9753	0.9750	0.975
33	0.9761	0.9753	0.976	0.9748	0.9753	0.975	0.9747	0.9758	0.975	0.9751	0.9753	0.975

The voltage obtained by ICA and NR methods in 3-dimensional mode for 33-bus test system in 24 hours is indicated in Figures 16 and 17 respectively. Figure 18 is compared the difference between obtained results by ICA and PSO. Table 7 shows the comparison of the best cost and running time between ICA, PSO, and NR.

VI. CONCLUSIONS

Because of the nature of future distribution network with high penetration of different DG sources, the structure of the conventional distribution networks will be changed. Under such conditions, the conventional power flow algorithms may encounter with some major deficiencies. In this paper, the application of heuristic algorithm to solve the power flow problem in smart distribution grids is investigated.

The methodology is tested in two-distribution network with and without DG units considering 24 hours load profile to show the ability and flexibility of the algorithms for solving the power flow problem in active distribution networks. The implementation of the method is simple and the algorithm has high potential in considering of many kinds of constraints. The results show the efficiency and flexibility of the proposed procedure.

NOMENCLATURES

P_i : Active power at bus i
 f : Cost function
 Q_i : Reactive power at bus i
 $N_{country}$: Number of countries
 n : Number of buses
 N_{col} : Number of colonies
 V_i : Voltage magnitude at bus i
 N_{imp} : Number of Imperialists
 δ_i : Phase angle of voltage at bus i
 c_n : n th imperialist cost
 $|Y_{ij}|$: Admittance matrix magnitude
 C_n : Normalized cost of n th imperialist
 P_i^{sch} : Scheduled real power at bus i
 $\max\{c_i\}$: The most cost among the imperialists
 Q_i^{sch} : Scheduled reactive power at bus i
 NC_n : Initial number of colonies at n th empire
 P_i^{calc} : Calculated real power at bus i
 d : Distance between colony and the imperialist
 Q_i^{calc} : Calculated reactive power at bus i
 β and γ : Parameters randomly modify search area
 Z : Objective function
 θ and x : Random numbers
 $|V_{i,min}|$: Minimum of voltage magnitude
 TC_n : Total cost of imperialist and its colonies
 $|V_{i,max}|$: Maximum value of voltage
 ζ : Positive number less than 1
 $|\delta_{i,min}|$: Minimum value of phase angle
 NTC_n : Normalized total cost of n th empire
 $|\delta_{i,max}|$: Maximum value of phase angle
 k : Number of iterations
 V_i, S_i : Velocity and position of particle i
 C_1, C_2 : Acceleration constants
 $p\text{-best}_i$: Best position of particle i
 $rand$: Uniform random values in range [0,1]
 $g\text{-best}$: Best position among all particles
 $iter$: Current iteration number
 N : Dimensional of optimization
 w : Inertia weight factor
 x_i : Variable of socio-political country i

REFERENCES

[1] W.G. Tinney, C.E. Hart, "Power Flow Solution by Newton's Method", IEEE Transactions on Power Apparatus, Vol. 86, pp. 1449-1457, 1967.
 [2] B. Stott, O. Alsac, "Fast Decoupled Load Flow", IEEE Transactions on Power Apparatus Systems, Vol. 93, pp. 859-869, 1974.
 [3] D. Rajicic, D. Tamura, "Modification to Fast Decoupled Load Flow for Networks with High R/X Ratios", IEEE Transactions on Power System, Vol. 3, No. 2, pp. 743-746, 1981.
 [4] D. Shirmohammadi, H.W Hong, A. Semlyen, G.X. Luo, "A Compensation Based Power Flow Method for Weakly Meshed Distribution and Transmission Networks", IEEE Transactions on Power Systems, Vol. 3, No. 2, pp. 753-762, 1988.
 [5] S.A. Rajagopalan, "New Computational Algorithm for Load Flow Study of Radial Distribution Systems", Comp. & Elect. Eng., Vol. 5, pp. 225-230, 1978.
 [6] J.B.V. Subrahmanyam, "Load Flow Solution of

Unbalanced Radial Distribution Systems", Journal of Theoretical and Applied Information Technology, Vol. 6, No. 1, pp. 40-51, 2005.
 [7] D. Khaniya, A.K. Srivastava, N.N. Schulz, "Distribution Power Flow for Multiphase Meshed or Radial Systems", IEEE Power Sympos., Calgary, 2008.
 [8] L. Zhang, W. Tang, H. Guan, "The Back-Forward Sweep-Based Power Flow Method for Distribution Networks with DGs", IEEE Power Electronics and Intelligent Transportation System Conf., Shenzhen, 2009.
 [9] R. Babu, M.P.V.V.R. Kumar, V. Hemachandra, M.P.R. Vanamali, "A Novel Power Flow Solution Methodology for Radial Distribution Systems", Computational Technologies in Electrical and Electronics Engineering Conf., Listvyanka, 2010.
 [10] K.D. Singh, S. Ghosh, "A New Efficient Method for Load-Flow Solution for Radial Distribution Networks", Przewlad elektrotechniczny (Electrical Review), 2011.
 [11] N.P. Padhy, K. Jasthi, "A Load Flow Algorithm for Practical Distribution Systems Comprising Wind Generators", IEEE Energy, Automation, and Signal Conference. Bhubaneswar, Odisha, 2011.
 [12] K. Prakash, M. Sydulu, "Topological and Primitive Impedance Based Load Flow Method for Radial and Weakly Meshed Distribution Systems", Iranian Journal of Electrical and computer engineering, Vol. 10, No. 1, pp. 10-18, 2011.
 [13] T.M. Krishna, B. Subrahmanyam, D. Reddy, N.V. Ramana, S. Kamakshaiyah, "Power Flow Algorithm for Radial Distribution System with Voltage Sensitive Loads", IEEE India Conference, Kochi, 2012.
 [14] A. Rabih, "Radial Distribution Load Flow Using Conic Programming", IEEE Transaction on Power Systems, Vol. 21, No. 3, pp. 1458-1459, 2006.
 [15] T. Thakur, D. Jaswanti, "A New Approach to Load Flow Solutions for Radial Distribution System", IEEE PES Transmission and Distribution Conference, 2006.
 [16] B. Das, "Radial Distribution System Power Flow Using Interval Arithmetic", Inter. Journal of Electrical Power & Energy Systems, Vol. 24, pp. 827-836, 2002.
 [17] A.C. Santos, M. Nanni, M.R. Mansour, A.C.B Delbem, J.B.A. London, N.G. Bretas, "A Power Flow Method Computationally Efficient for Large-Scale Distribution Systems", Transmission and Distribution Conference and Exposition Conf., Bogota, 2008.
 [18] J. Chakavorty, M. Gupta, "A New Method of Load Flow Solution of Radial Distribution Networks", International Journal of Electronics and Communication Engineering, Vol. 5, No. 1, pp. 9-22, 2012.
 [19] S.V.D. Anil Kumar, K. Ramesh Reddy, "Computation of the Power Flow Solution of a Radial Distribution System for Harmonic Components", International Journal of Energy Information and Communications, Vol. 4, No. 1, pp. 37-49, 2013.
 [20] S. Manikandan, S. Sasitharan, J. Viswanatha Rao, "A Fast Power Flow Solution of Radial Distribution Networks", International Journal of Electrical Engineering, Vol. 6, No. 4, pp. 373-379, 2013.
 [21] M. Kleinberg, K. Miu, C. Nwankpa, "Radial Distribution Power Flow Studies in a Remotely

Distributed Environment", IEEE Circuits and Systems Symposium, Island of Kos, 2006.

[22] P. Zhang, S. Lee, "Probabilistic Load Flow Computation Using the Method of Combined Cumulants and Gram-Charlier Expansion", IEEE Trans. Power Syst., Vol. 19, No. 1, pp. 676-682, 2004.

[23] D. Lei, Z. Chuan-Cheng, Y. Yi-han, Z. Pei, "Improvement of Probabilistic Load Flow to Consider Network Configuration Uncertainties", Power and Energy Eng. Conf., Asia-Pacific, 2009.

[24] L. Dong, W. Cheng, H. Bao, Y. Yang, "Probabilistic Load Flow Analysis for Power Systems Containing Wind Farms", Power and Energy Eng. Conf., Asia-Pacific, 2010.

[25] L. Hong, L. Shi, L. Yao, Y. Ni, M. Bazargan, "Study on Fuzzy Load Flow with Consideration of Wind Generation Uncertainties", Trans. and Dist. Conf. and Exposition, Asia-Pacific, 2009.

[26] E. Atashpaz Gargari, C. Lucas, "Imperialist Competitive Algorithm - An Algorithm for Optimization Inspired by Imperialist Competitive", IEEE Congress on Evolutionary Computation, Singapore, 2007.

[27] J. Kennedy, R. Eberhart, "Particle Swarm Optimization", International Conference on Neural Networks, Perth, WA, 1995.

[28] M. Kashem, V. Ganapathy, G.B. Jasmon, M.I. Buhari, "A Novel Method for Loss Minimization in Distribution Networks", International Conference on Electric Utility Deregulation and Restructuring and Power Technologies, London, 2000.

[29] M.E. Baran, F.F. Wu, "Network Reconfiguration in Distribution Systems for Loss Reduction and Load Balancing", IEEE Trans on Power Delivery, Vol. 4, No. 2, pp. 1401-1407, 1989.

[30] M.E. Baran, F.F. Wu, "Optimal Capacitor Placement on Radial Distribution Systems", IEEE Trans. on Power Delivery, Vol. 4, No. 1, pp. 725-734, 1989.

BIOGRAPHIES



Nima Nikmehr was born in 1990 in Iran. He received B.Sc. degree in Electrical Engineering from Shahid Madani University, Tabriz, Iran in September 2012. At the present, he is M.Sc. student in Electric Power Engineering at Islamic Azad University, Iran. His research interests include evolutionary algorithms and intelligence computing in power systems, probabilistic modeling in power systems, operation, and economic aspect of micro-grids.



Sajad Najafi Ravadanegh was born in 1976 in Iran. He received B.Sc. degree in Electrical Engineering from University of Tabriz, Iran in 2001 and M.Sc. and Ph.D. degrees in Electrical Engineering from Amirkabir University of Technology, Tehran, Iran in 2003 and 2009, respectively. Currently, he is an Assistant Professor of Electrical Engineering Department, Shahid Madani University, Tabriz, Iran and responsible for Smart Distribution Grid Research Lab. His research interests include power system stability and control, special protection schemes, power system controlled islanding, evolutionary algorithms and intelligence computing in power systems, distribution system planning, energy management, nonlinear dynamic, and chaos. He is also the author and the co-author of over 33 technical papers.